

CH Dimension options

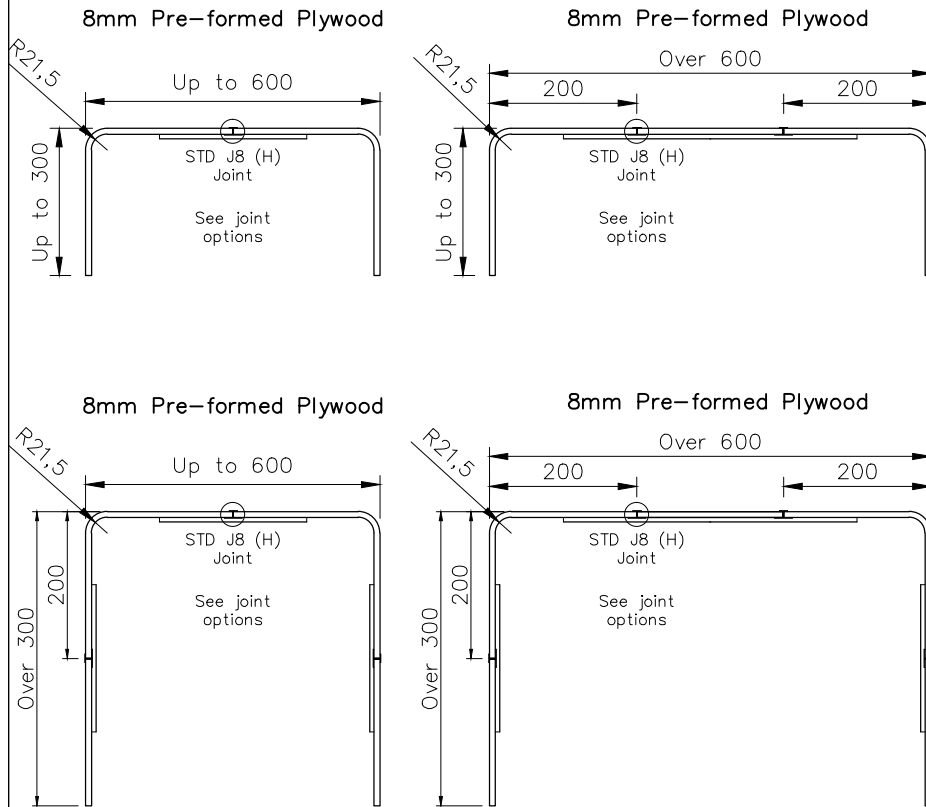

AVAILABLE FINISHES & ASSEMBLY JOINTS
 White Melamine (J8, J2, J3)
 Laminate, any postformable laminate (J2, J3, J4 or J5)

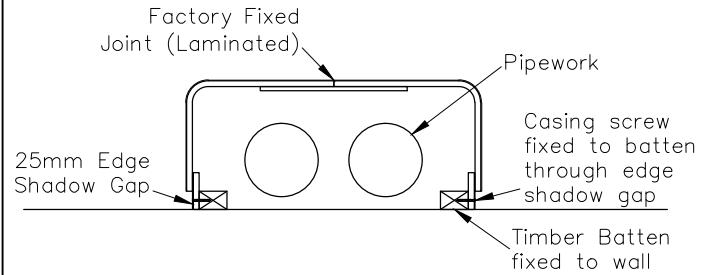

EXAMPLES OF IN-SITU DETAILS

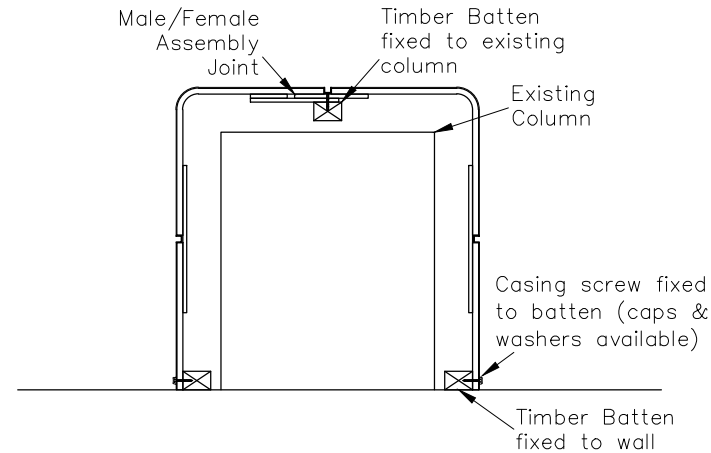

JOINT OPTIONS STD J8 (H) JOINT

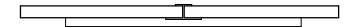

J2



10mm Black UPVC

J3 (TOP HAT)

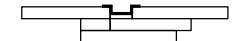

15mm Aluminium extrusion & decorative insert

J4

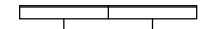

Sealed joint (laminated only)

J5

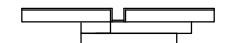

Lipped joint any width nom. 10 to 20mm

PENDOCK

Pendock.
 Halesfield 19, Telford, Shropshire, TF7 4QT.
 Tel: +44 (0) 1952 580590 Fax: +44 (0) 1952 587805
 E-mail: technical@pendock.co.uk
 Web: www.pendock.co.uk

THIS DRAWING MUST NOT BE SCALED

© TP MANUFACTURING
 PENDOCK, HALESFIELD 19, TELFORD, SHROPSHIRE TF7 4QT
 TEL: +44 (0) 1952 580590 FAX: +44 (0) 1952 587805
 email: sales@pendock.co.uk or technical@pendock.co.uk

CH CASINGS

DRAWN BY	SCALE	DATE
SL	NTS	9/3/15

AVAILABLE IN 2.5 OR 3m LENGTHS